

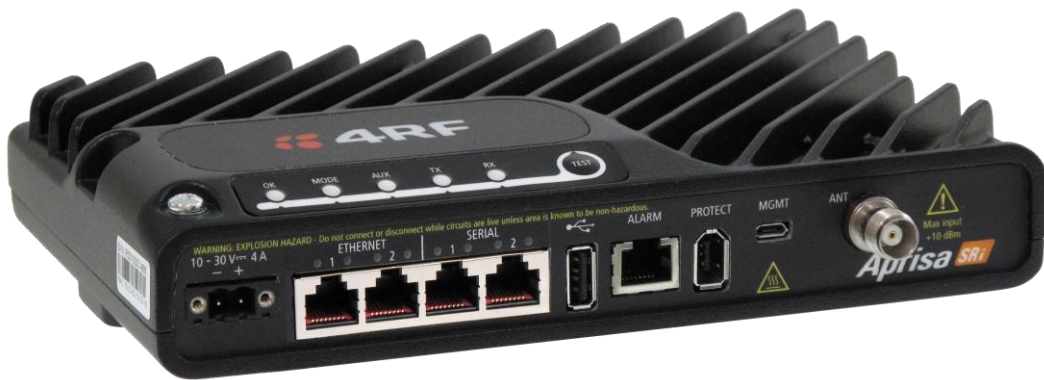

Aprisa **SRi**



Quick Start Guide

Aprisa SRi Radio

May 2024

Version 1.5.0

Aprisa SRi Quick Start Guide 2024 4RF Limited. All rights reserved. This document is protected by copyright belonging to 4RF Limited and may not be reproduced or republished in whole or part in any form without the prior written permission of 4RF Limited. While every precaution has been taken in the preparation of this literature, 4RF Limited assumes no liability or errors and omissions, or from any damages resulting from use of this information. The contents and any product specifications within it are subject to revision due to ongoing product improvements and may change without notice. Aprisa and the 4RF logo are trademarks of 4RF Limited. All other marks are the property of their respective owners.

1. Introduction	3
Front Panel Connections.....	3
LED Display Panel	4
Ethernet and RS-232 RJ-45 LED Indicators	4
2. Installation	5
2.1. Install the Aprisa SRi Radio and Connect the Protection Earth	6
2.2. Connect the Antenna and Apply Power to the Aprisa SRi Radio	7
2.3. Connect to the Aprisa SRi Radio (via SuperVisor or CLI).....	8
3. Setup the Aprisa SRi Radio	9
4. Monitoring and Troubleshooting the Aprisa SRi Radio	10
4.1. Monitor the Aprisa SRi Radio Signal Strength.....	10
4.2. Fault Management and Troubleshooting	10
4.3. Performance Monitoring (RF and Data Traffic).....	11
5. Compliance Considerations	12
Canada.....	13
Mexico	13

1. Introduction

The 4RF Aprisa SRi is a Point-To-Multipoint (PMP) digital radio providing 915 MHz Industrial (unlicensed) License Free Spread Spectrum communications. The radios carry a combination of serial data and Ethernet data between the base station and remote radios. A single Aprisa SRi is configurable as a Point-To-Multipoint base station or remote radio.

This guide provides quick startup and basic installation instructions for the Aprisa SRi radio shown in the next figure below.

A more detailed User Manual is also available. Refer to the User Manual for important warnings, cautions and notes and any detailed management relating to faults, configuration, maintenance, performance monitoring, and security.

Front Panel Connections

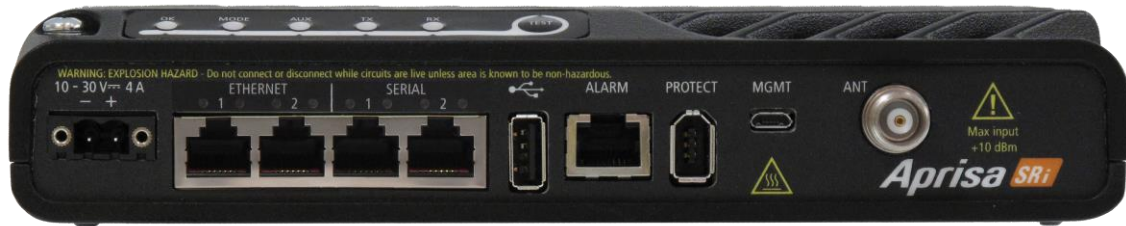

All connections to the radio are made on the front panel. The functions of the connectors are (from left to right):

Designator	Description
10 - 30 VDC; 4A	+10 to +30 VDC (negative ground) DC power input using Molex 2 pin male screw fitting connector. AC/DC and DC/DC power supplies are available as accessories.
ETHERNET 1 & 2	Integrated 10Base-T/100Base-TX layer-3 Ethernet switch using RJ45 connectors. Used for Ethernet user traffic and product management.
SERIAL 1 & 2	Two ports of RS-232 serial using RJ45 connector. Used for RS-232 asynchronous user traffic.
	Host Port using a USB standard type A connector. Used for software upgrade and diagnostic reporting and optional: 1x RS-232 asynchronous port with USB to RS-232 converter.
ALARM	Alarm Port using an RJ45 connector. Used for two alarm inputs and two alarm outputs.
MGMT	Management Port using a USB micro type B connector. Used to access the radio Command Line Interface (CLI).
PROTECT	Used for the Aprisa SRi Protected Station.
ANT	TNC, 50 ohm, female connector for connection of antenna feeder cable for half duplex RF operation.

LED Display Panel

The Aprisa SRi has an LED Display panel which provides on-site alarms / diagnostics without the need for PC.

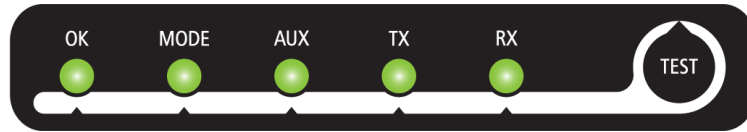

The LEDs indicate the following conditions:

	OK	MODE	AUX	TX	RX
Flashing Red		<i>Radio has not registered</i>			
Solid Red	<i>Alarm present with severity Critical, Major and Minor</i>			<i>TX path fail</i>	<i>RX path fail</i>
Flashing Orange		<i>Diagnostics Function Active OTA software distribution</i>	<i>Management traffic on the USB MGMT port</i>		
Solid Orange	<i>Alarm present with Warning Severity</i>		<i>Device detect on the USB host port (momentary)</i>		
Flashing Green	<i>Software Upgrade Successful</i>		<i>Tx / Rx Data on the USB host port</i>	<i>RF path TX is active</i>	<i>RF path RX is active</i>
Solid Green	<i>Power on and functions OK and no alarms</i>	<i>Processor Block is OK</i>	<i>USB interface OK</i>	<i>Tx path OK</i>	<i>Rx path OK</i>

LED Colour	Severity
Green	No alarm - information only
Orange	Warning alarm
Red	Critical, major or minor alarm

Ethernet and RS-232 RJ-45 LED Indicators

LED	Status	Ethernet Explanation	RS-232 Explanation
Green	On	Ethernet signal received	RS-232 device connected
Orange	Flashing	Data traffic present on the interface	Data present on the interface

2. Installation

The Aprisa SRi is shipped to you in a box containing an Aprisa SRi radio fitted with power connector.

The following figure shows a typical installation of the unit. The following sub-section describe the main requirements for installation.

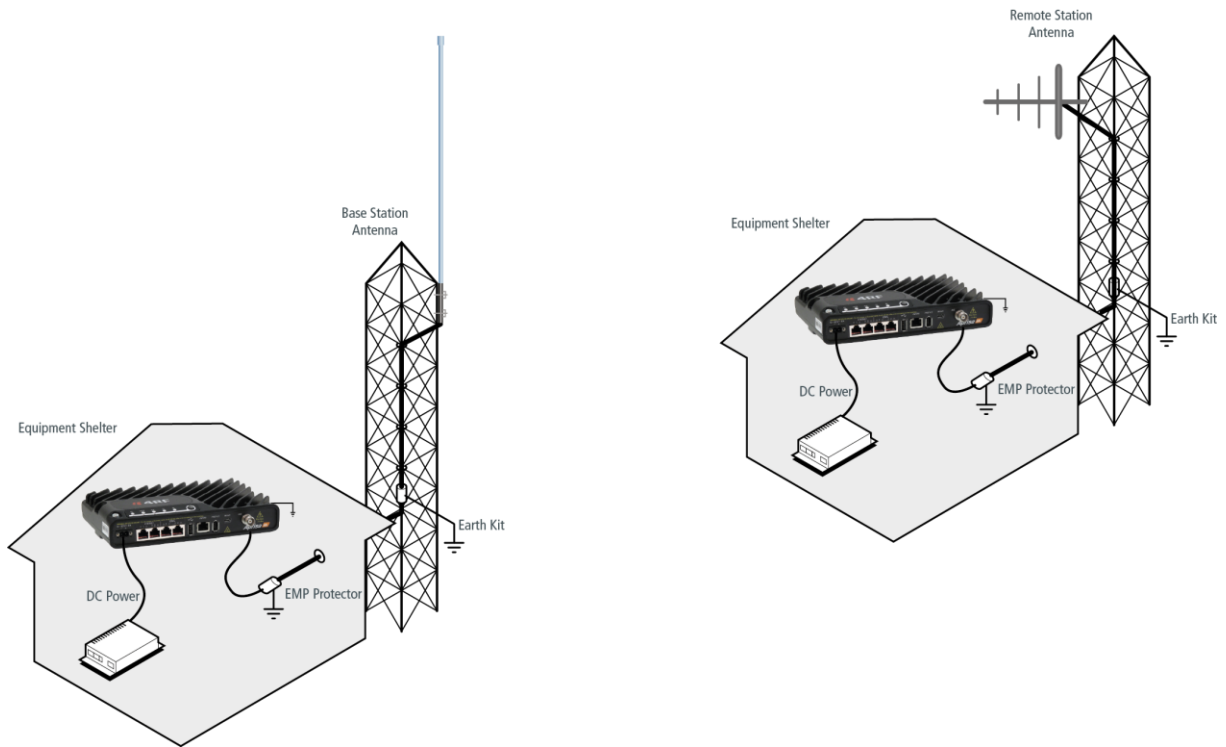

2.1. Install the Aprisa SRi Radio and Connect the Protection Earth

The Aprisa SRi has four threaded holes (M4) in the base and two holes (for M5 screws) through the enclosure for mounting. Mounting options include:

- DIN rail mounting with the DIN Rail Mounting Bracket (optional accessory part number ‘APGA-MBRK-DIN’)
- Rack shelf mounting (optional accessory part number ‘APGA-MR19-X1U’).
- Wall Mounting.
- Outdoor enclosures

Aprisa SRi DIN rail mounting:

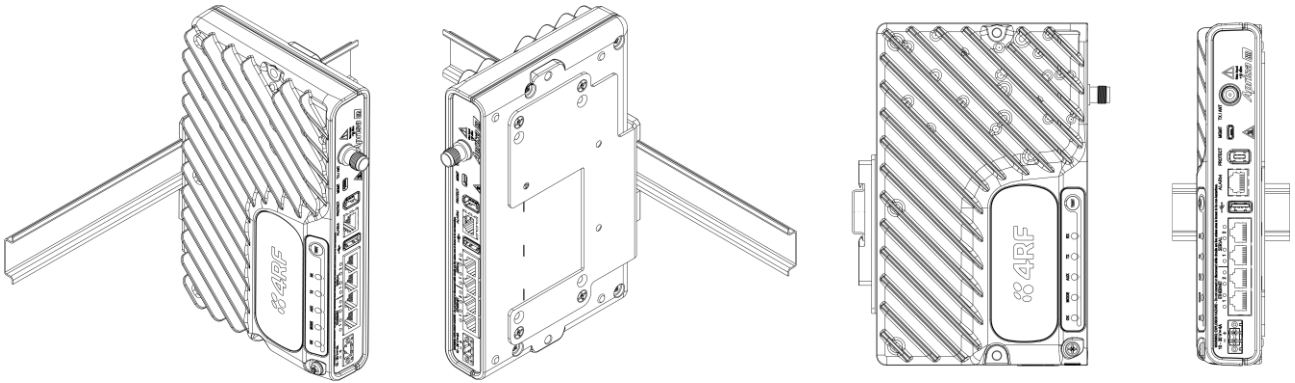

Aprisa SRi Wall and Rack Shelf mounting:

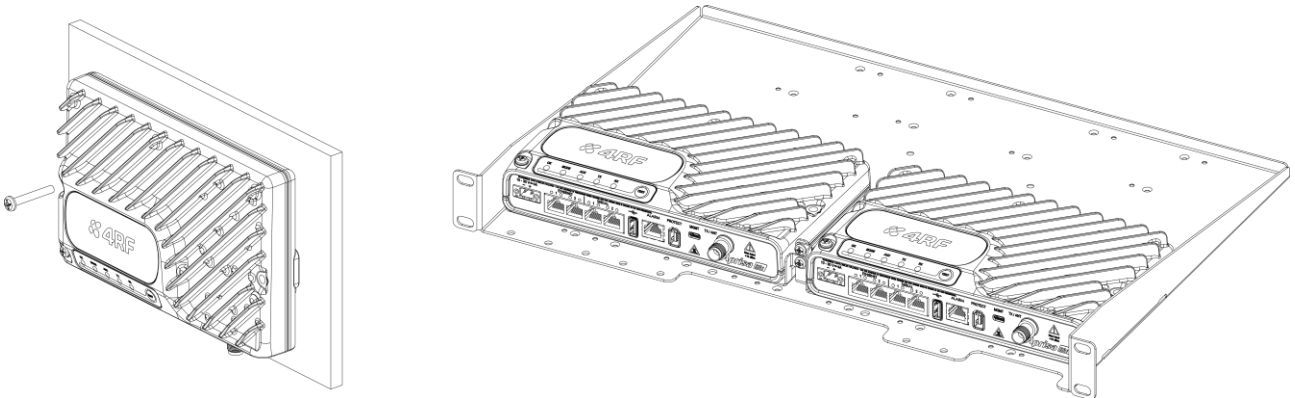

The Aprisa SRi has an earth connection point on the top left and the top right of the enclosure. Use the supplied M4 screws to earth the enclosure to a protection earth.

The antenna feeder cable should use grounding kits for lightning protection as specified or supplied by the coaxial cable manufacturer to properly ground or bond the cable outer.



Warning: If the Aprisa SRi is operated in an environment where the ambient temperature exceeds 50°C, the Aprisa SRi must be installed within a restricted access location to prevent human contact with the enclosure heatsink.

2.2. Connect the Antenna and Apply Power to the Aprisa SRi Radio

Connect the antenna to the antenna port TNC female connector. If the antenna is not available, terminate the 'TX / Ant' port with a TNC male 50 ohm terminator (10 Watts min).

Warning: Do not directly connect the radio antenna port without attenuation of at least 40 dB. The receiver can be damaged if signals greater than +10 dBm are applied to the antenna port.



The Aprisa SRi is operated from a DC source of voltage between +10 VDC and +30 VDC (negative earth) and consumes up to 20 Watts. External power supplies are available from 4RF as accessories (see the Aprisa SRi User Manual).

The power connector (Molex 2 pin female) is supplied fitted to the radio. Wire your power source to the power connector (- / +) and plug the connector into the radio. The connector screws should be fastened to secure the connector.



Note: The radio fuses will blow if the connected power supply is over voltage, or the polarity is reversed. Two spare fuses are located inside the enclosure (see the 'Spare Fuses' section of the Aprisa SRi User Manual).

Note: The factory default for the Terminal Operating Mode is set to Remote Station for all radios.

Turn your power source on. All the radio LEDs will flash orange for two seconds.

Then the OK, AUX, TX and RX LEDs will light green, and the TX and RX LEDs will also flash as traffic is transmitted / received.

The MODE LED will flash red to indicate that the radio is unregistered.

When the radio has been configured and has registered with the network, the MODE LED will turn green (so all LEDs are now green).

The radio is now ready to operate.

If the radio has an active alarm, such as being unable to communicate with the base station, the OK LED will go red.

Warning: On link operation, RF energy is radiated from the antenna. Do not stand in front of the antenna.

2.3. Connect to the Aprisa SRi Radio (via SuperVisor or CLI)

The Aprisa SRi has a factory default IP address of 169.254.50.10 with a subnet mask of 255.255.0.0.

Each radio in the Aprisa SRi network must be set up with a unique IP address on the same subnet.

If the IP address of the radio is known or is the default IP address, it can be changed via the Ethernet port:

- Setup your PC for a compatible IP address e.g. 169.254.50.1 with a subnet mask of 255.255.0.0.
- Connect your PC network port to one of the Aprisa SRi Ethernet ports.
- Open a browser and enter `https://169.254.50.10`.

Note: The Aprisa SRi has a Self-Signed security certificate which may cause the browser to prompt a certificate warning. It is safe to ignore the warning and continue. The valid certificate is 'Issued By: 4RF-APRISA' which can be viewed in the browser.

- Login to the radio with the default login 'admin' and password 'admin'.
- Change the IP address, Subnet mask and Gateway to network compatible IP addresses.

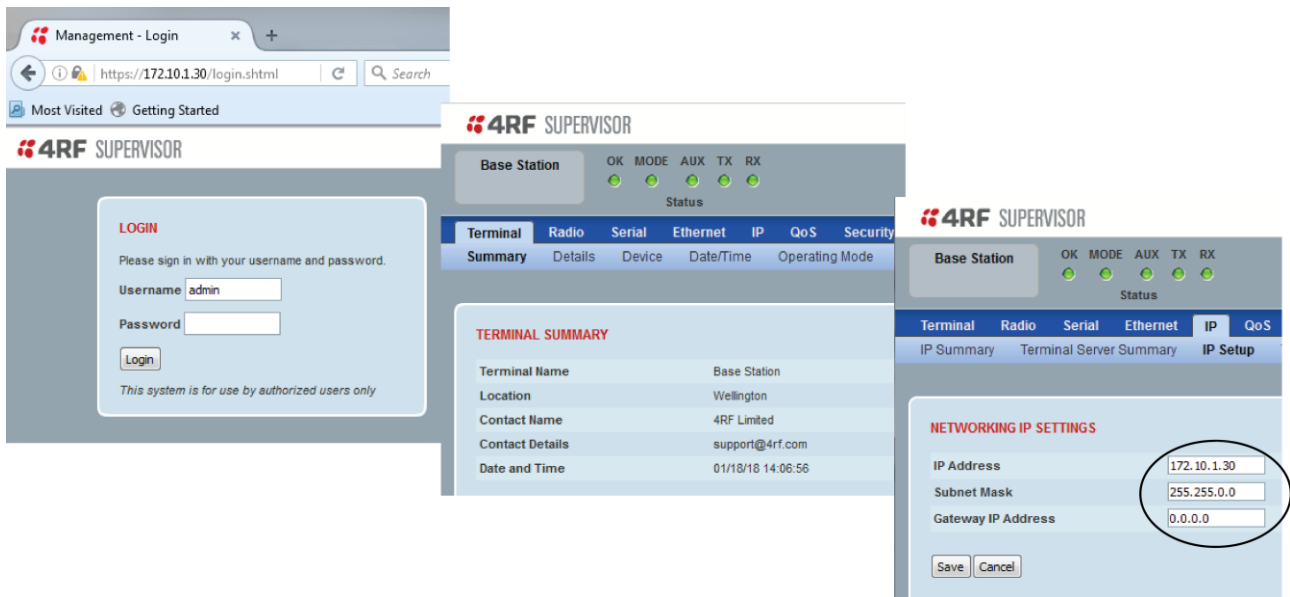

The image displays three overlapping screenshots of the 4RF SUPERVISOR web interface. The leftmost screenshot shows the 'Management - Login' page with a browser address bar at `https://172.10.1.30/login.shtml`. The 'LOGIN' form includes fields for 'Username' (containing 'admin') and 'Password', and a 'Login' button. The middle screenshot shows the 'Terminal Summary' page, displaying details for a 'Base Station' located at 'Wellington', with contact information for '4RF Limited' and a date/time of '01/18/18 14:06:56'. The rightmost screenshot shows the 'Networking IP Settings' page, where the 'IP Address' is set to '172.10.1.30', the 'Subnet Mask' is '255.255.0.0', and the 'Gateway IP Address' is '0.0.0.0'. The IP address field is circled in red.

If the IP address of the radio is unknown, it can be changed via the Command Line Interface on the radio MGMT USB port:

- Connect your PC USB port to the Aprisa SRi MGMT USB port. USB to UART Bridge VCP Drivers are required to connect the radio USB port to your PC. You can download and install the relevant driver from; <https://www.silabs.com/products/development-tools/software/usb-to-uart-bridge-vcp-drivers>.
- Set the PC serial port to 38,400 baud, 8 data bits, no parity and 1 stop bit, with no hardware flow control.
- Login to the radio with the default login 'admin' and password 'admin'.
- At the command prompt `>>` type `'cd APRISASR-MIB-4RF'` and enter.
 - type `'set termEthController1IpAddress xxx.xxx.xxx.xxx'` and enter.
 - type `'set termEthController1SubnetMask 255.255.0.0'` and enter.
 - type `'set termEthController1Gateway xxx.xxx.xxx.xxx'` and enter.

3. Setup the Aprisa SRi Radio

The Aprisa SRi has a factory default ‘Terminal Operating Mode’ of Remote Station.

One radio in the Aprisa SRi network must be setup as a Base Station.

The other radios in the Aprisa SRi network are set up as Remote Stations.

Set the required ‘Ethernet Operating Mode’.

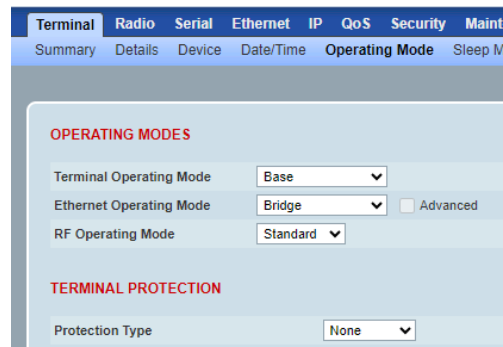

Set the unique radio ‘Base Station ID’ to be the same in your entire network. Every base station and its attached remote radios (i.e. base station network) shall have a unique ‘Base station ID’ in case of close proximity or close coverage between two or more base station networks.

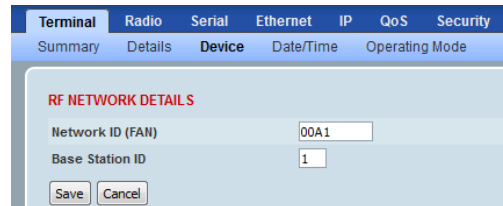

Set the Aprisa SRi TX Power and Channel Size to comply with your license.

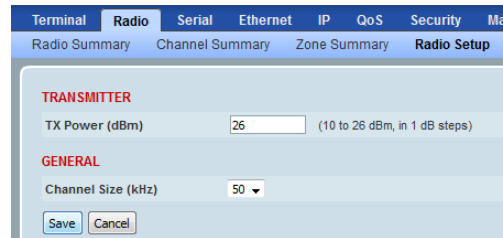

Setup the Aprisa SRi Zones / Channels.

Specific channels within the selected zone hop can be disabled if there is a known transmission within the channel that may cause interference to the operation of this network. The minimum number of enabled channels is 50.

If a channel is selected in a zone that is disabled, the zone will be enabled when the channel selection is saved. The default is all zones enabled.

The zone frequencies are pre-defined in the Aprisa SRi for the zone number. The zone frequencies are spaced at 62.5 kHz.

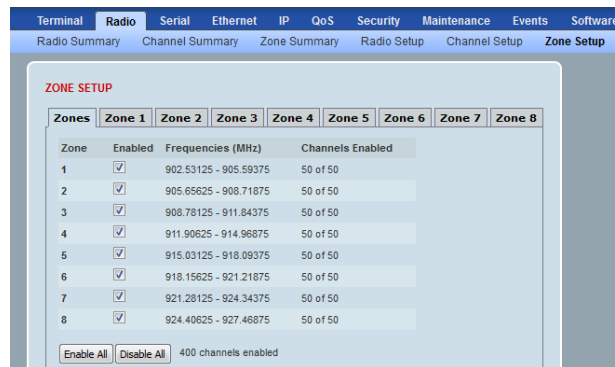

You can now configure the remaining terminal and network parameters and settings. Please refer to the Aprisa SRi User Manual for detailed instructions, such as the radio security settings and more.

4. Monitoring and Troubleshooting the Aprisa SRi Radio

4.1. Monitor the Aprisa SRi Radio Signal Strength

When the network is installed, the radio signal strength can be monitored on remote stations by setting the radio to Test Mode.

To enter Test Mode, press and hold the TEST button on the radio LED panel until all the LEDs flash green (about 3 - 5 seconds).

In Test Mode, the LED Display panel presents a real time visual display of the RSSI. This can be used to adjust the antenna for optimum signal strength.

Note: The response time is variable and can be up to 5 seconds.

To exit Test Mode, press and hold the TEST button until all the LEDs flash red (about 3 - 5 seconds).

The OK, MODE and AUX LEDs will be solid green, and the TX and RX LEDs will be solid or flash green if the network is operating correctly.

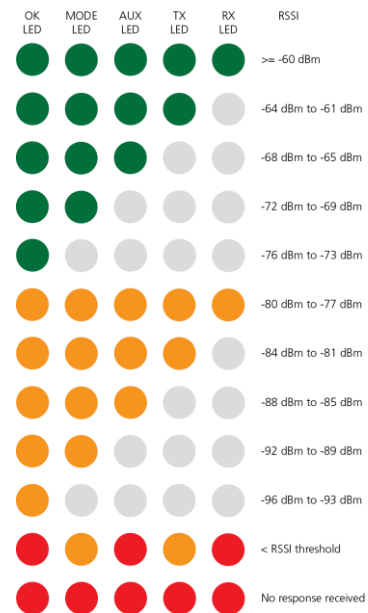

For more information, please refer to the Aprisa SRi User Manual available from the 4RF website <https://www.4rf.com/secure> (login required).

4.2. Fault Management and Troubleshooting

The Aprisa SRi supports extensive alarms for every section and building block of the device including the interfaces. SuperVisor allows user to view the main summary alarm at the top of the SuperVisor page which mimic the device LEDs and in addition all the detailed alarms of the device (see SuperVisor > Events > Alarm Summary). In addition, SuperVisor allows user to troubleshoot any alarm issue by using the event history log page for more information about the alarm (see SuperVisor > Events > Event History).

For more information see the Aprisa SRi user manual.

Log ID	Date/Time	Event ID	Description	State	Severity	Additional Information
113	12/12/2018, 07:11	26	User Authentication Succeeded	inactive	information	SuperVisor, User admin, Local auth OK, IP Addr 172.10.1.1
112	12/12/2018, 07:07	30	Software Start Up	inactive	information	Power on Reset
111	12/12/2018, 05:54	72	User Session Logout	inactive	information	SuperVisor, User admin, IP Addr 172.10.1.1
110	12/12/2018, 05:39	89	User Account Activity	inactive	information	User Account: admin_factory account created
109	12/12/2018, 05:29	26	User Authentication Succeeded	inactive	information	SuperVisor, User admin, Local auth OK, IP Addr 172.10.1.1
108	12/12/2018, 05:27	30	Software Start Up	inactive	information	User Reboot (Management)
107	12/12/2018, 05:27	72	User Session Logout	inactive	information	SuperVisor, User admin, IP Addr 172.10.1.1
106	12/12/2018, 05:24	39	Software Restart Required	active	warning	Ethernet Operating Mode Changed

4.3. Performance Monitoring (RF and Data Traffic)

The Aprisa SRi supports extensive performance monitoring statistics and diagnostic per device and per data ports. The Aprisa SRi Terminal, Serial, Ethernet, Radio, and User Selected Monitored Parameter results have history log views for both Quarter Hourly and Daily. SuperVisor allows user to view trends of the performance monitoring parameters in graph or tabular format (see SuperVisor > Monitoring).

For more information, see the Aprisa SRi user manual.

The screenshots show the 4RF SUPERVISOR interface with the 'Monitoring' tab selected. The interface includes a top navigation bar with various monitoring categories and a main content area displaying specific parameter data.

POWER SUPPLY PARAMETERS

Parameter	Value	User
Current VDC Power Supply	12.484 V	<input type="checkbox"/>
Current 3.3V Power Supply	3.305 V	<input type="checkbox"/>
Current 5.0V Power Supply	5.246 V	<input type="checkbox"/>
Current 15.0V Power Supply	13.043 V	<input type="checkbox"/>

RADIO PARAMETERS

From	Node Name	Rx RSSI	Rx Freq Error	Rx Mod	Rx Timestamp	User
172.10.1.31	Remote Radio	-61.2 dBm	12 Hz	64QAM Lo	12/12/2018, 07:31	<input type="checkbox"/>

ETHERNET PORT PARAMETERS

Port 1 Tx	Port 1 Rx	Port 2 Tx	Port 2 Rx	User
Packets	120			<input type="checkbox"/>
Bytes	30,823			<input type="checkbox"/>
Packets equal to 64 Bytes	60			<input type="checkbox"/>
Packets 65 to 127 Bytes	11			<input type="checkbox"/>
Packets 128 to 255 Bytes	9			<input type="checkbox"/>
Packets 256 to 511 Bytes	0			<input type="checkbox"/>
Packets 512 to 1023 Bytes	39			<input type="checkbox"/>
Packets 1024 to 1536 Bytes	1			<input type="checkbox"/>
Broadcast Packets	2			<input type="checkbox"/>
Multicast Packets	6			<input type="checkbox"/>
VLAN Frames	0			<input type="checkbox"/>
VLAN Frames dropped	0			<input type="checkbox"/>

SERIAL PORT PARAMETERS

Port 1	Port 2	USB Serial Port	User
Maximum Capacity	115,200 bps		<input type="checkbox"/>
Packets Transmitted	0		<input type="checkbox"/>
Bytes Transmitted	0		<input type="checkbox"/>
Packets Received	0		<input type="checkbox"/>
Bytes Received	0		<input type="checkbox"/>
Errored Bytes Received	0		<input type="checkbox"/>
Dropped Bytes (Congestion)	0		<input type="checkbox"/>

5. Compliance Considerations

The Aprisa SRi is a professional radio product and as such must be installed by a suitably trained and qualified installer who is aware of the local regulatory requirements existing at the time of installation and is capable of ensuring that the regulations are adhered to.

The maximum Equivalent Isotropic Radiated Power (EIRP) permitted from the Aprisa SRi is regulated and must not exceed the limits provided in the following table. To meet this regulatory requirement, knowledge of the antenna gain, and feeder cable loss must be known before setting the transmitter output power.

Regulatory Requirement	Frequency Range	Maximum EIRP ¹	SRi Equivalent Maximum Average Power (R_{dBm})
USA, FCC Part 15.247	902 MHz to 928 MHz	+36 dBm PEP	+32 dBm
Canada, ISED RSS-247	902 MHz to 928 MHz	+36 dBm PEP	+32 dBm
Australia, ACMA AS/NZS 4268	915 MHz to 928 MHz	+30 dBm	+30 dBm
New Zealand, General User Radio Licence for Short Range Devices	915 MHz to 928 MHz	+30 dBm	+30 dBm
New Zealand, General User Radio Licence for Short Range Devices	920 MHz to 928 MHz	+36 dBm	+36 dBm
Brazil, Act No. 14.448, of December 4, 2017	902 MHz to 907.5 MHz & 915 MHz to 928 MHz	+36 dBm PEP	+30 dBm
Mexico, NOM-208-SCFI-2016	902 MHz to 928 MHz	+36 dBm PEP	+30 dBm
Peru	915 MHz to 928 MHz	+30 dBm	+30 dBm

The Aprisa SRi has a maximum mean output power of +26 dBm into a 50 ohm antenna which equates to a maximum peak power of +30 dBm PEP. To determine the maximum power to be set on the Aprisa SRi, the following installation parameters must be known:

1. Aprisa SRi equivalent average power for maximum permitted EIRP (specified in dBm) R_{dBm}
2. Antenna isotropic gain (specified in dBi) G_{dBi}
3. Feeder coax loss between Aprisa SRi and antenna (specified in dB/m) $L_{dB/m}$
4. Length of feeder coax between Aprisa SRi and antenna (specified in metres) d_m

From these the above information, the power setting of the Aprisa SRi (P_{dBm}) can be calculated to ensure operation within the regulatory requirements using the formula:

$$P_{dBm} = R_{dBm} + (d_m \times L_{dB/m}) - G_{dBi}$$

Antenna gain information can be obtained from the Antenna manufacturer and is either expressed in terms of dBi, referenced to an isotropic radiator, or dBd, referenced to a dipole.

If the gain is expressed in dBd, it can be converted to dBi by adding 2.15 dB to the gain value.

The following is an example of transmitter power calculations:

Antenna Type and Gain	Feeder Coax Length and Loss	Regulatory Limit	Maximum SRi Power Setting
Yagi, 11 dBi	10 m of ½" Heliac @ 0.11 dB/m gives 1.1 dB loss	+36 dBm PEP	22 dBm
Panel, 12 dBi	33 m of RG214 @ 0.22 dB/m gives 7.3 dB loss	+30 dBm	25 dBm
Dipole, 3.5 dBi	3 m of RG214 @ 0.22 dB/m gives 0.66 dB loss	+30 dBm	26 dBm
Grid, 18 dBi	15 m of ½" Heliac @ 0.11 dB/m gives 1.65 dB loss	+30 dBm	13 dBm

¹ These are correct at the time of printing. The installer must ensure that the installation complies with the regulatory requirements at the time of installation.

Canada

This radio transmitter Aprisa SRi ISED: 6772A-SI902M160 has been approved by Industry Canada to operate with the antenna types listed below with the maximum permissible gain indicated. Antenna types not included in this list, having a gain greater than the maximum gain indicated for that type, are strictly prohibited for use with this device.

Cet émetteur radio Aprisa SRi ISED: 6772A-SI902M160 a été approuvé par Industrie Canada pour fonctionner avec les types d'antenne énumérés ci-dessous avec le gain maximum autorisé indiqué. Les types d'antennes non inclus dans cette liste, ayant un gain supérieur au gain maximum indiqué pour ce type, sont strictement interdits d'utilisation avec cet appareil.

Mexico

La operación de este equipo está sujeta a las siguientes dos condiciones:

- (1) es posible que este equipo o dispositivo no cause interferencia perjudicial y
- (2) este equipo o dispositivo debe aceptar cualquier interferencia, incluyendo la que pueda causar su operación no deseada.

Este equipo ha sido diseñado para operar con las antenas que enseguida se enlistan y para una ganancia máxima de antena de 6 dBi.

El uso con este equipo de antenas no incluidas en esta lista o que tengan una ganancia mayor que 6 dBi quedan prohibidas. La impedancia requerida de la antena es de 50 ohms.